

TIPO D EQUIPADO CON TORNILLO PARA AJUSTE DE ALTURA Y 3
TORNILLOS DE APRIETE.

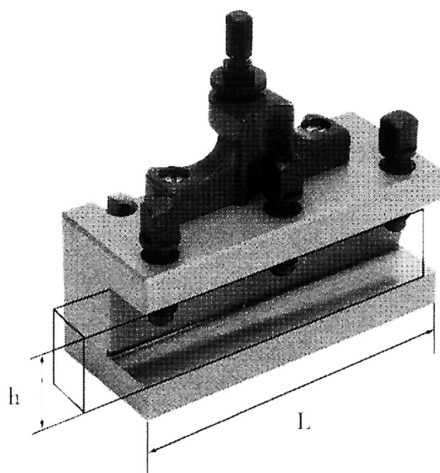

€124,00



L	80 mm
h	16 mm
Peso bruto	0,62 kg
Codigo de barras	8012667189990



Caja