

TIPO D EQUIPADO CON TORNILLO PARA AJUSTE DE ALTURA Y 3
TORNILLOS DE APRIETE.

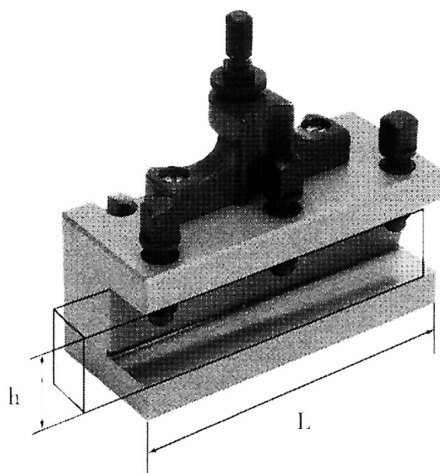

€286,00



L	150 mm
h	32 mm
Peso bruto	3,16 kg
Codigo de barras	8012667183141



Caja