

ART. D006/100
SEMI UNIVERSAL DIVIDING HEAD WITH TAILSTOCK AND
DIVIDING PLATES

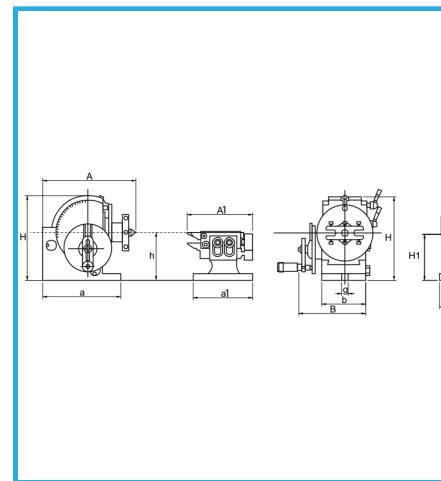

CHUCK NOT INCLUDED, EQUIPPED WITH HARDENED AND GROUND WORM SCREW AND PRECISION TAPERED ROLLER BEARINGS. ALLOWS THE OPERATOR TO...



A	193 mm
B	131 mm
H	173 mm
h	100 mm
a	166 mm
b	90 mm
G	16 mm
A1	175 mm
B1	87 mm
H1	102 mm
h1	100 mm
a1	130 mm
b1	82 mm
Suitable chuck	Ø 125 mm
g1	16 mm
Hole	ø 18 mm
MT	2
Ratio	1:40
Head tilt left and right	-10° - 90°
Plates holes	15-16-17-18-19-20-21-23-27-29-31-33-37-39-41-43-47-49
Net weight	16 kg
Gross weight	18,47 kg
EAN Code	8012667188092



Box