

DIN 69871/A, BALANCED CHUCK BODY, FOR CYLINDRICAL END MILLS
ACCORDING TO DIN 481, FOR MILLING CUTTERS WITH LONGITUDINAL
GROOVE...

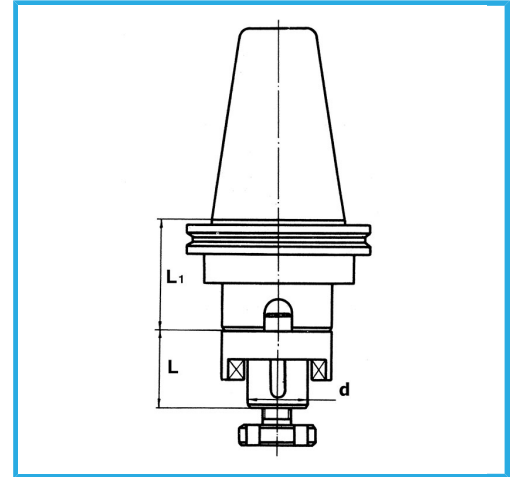

ISO	40
d-h6	16 mm
L	27 mm
L1	35 mm
Balancing rpm	12000
Gross weight	1,18 kg
EAN Code	8012667008031



Box

18Ni
CrMo5



Grounded