

DIN 69871/A, CON CUERPO EQUILIBRADO, PARA FRESAS CILÍNDRICAS SEGÚN DIN 481, PARA FRESAS CON RANURA LONGITUDINAL DIN...

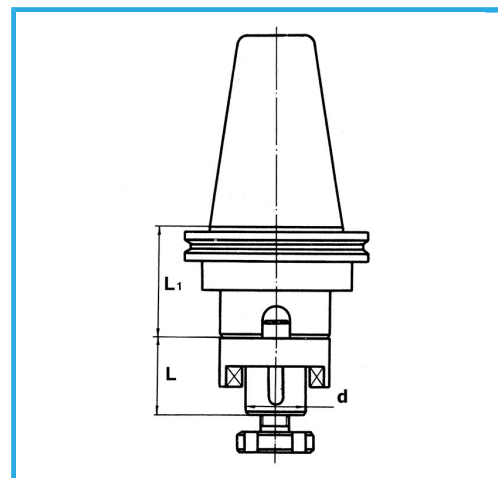

€165,00



ISO	50
Diámetro	22 mm
L	31 mm
L1	35 mm
Equilibrado rpm	12000
Peso bruto	4,31 kg
Codigo de barras	8012667008130



Caja

18Ni
CrMo5



Rectificado