

DIN 69871/A, BALANCED CHUCK BODY, FOR CYLINDRICAL END MILLS
ACCORDING TO DIN 481, FOR MILLING CUTTERS WITH LONGITUDINAL
GROOVE...

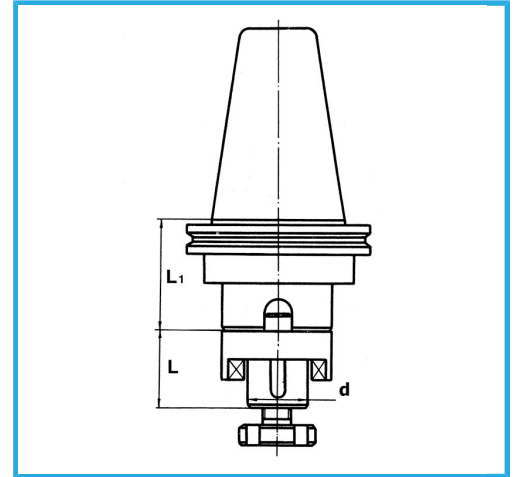

ISO	40
d-h6	32 mm
L	38 mm
L1	45 mm
Balancing rpm	12000
Gross weight	1,70 kg
EAN Code	8012667008062



Box

18Ni
CrMo5



Grounded