

DIN 69871/A, BALANCED CHUCK BODY, FOR CYLINDRICAL END MILLS ACCORDING TO DIN 481, FOR MILLING CUTTERS WITH LONGITUDINAL GROOVE...

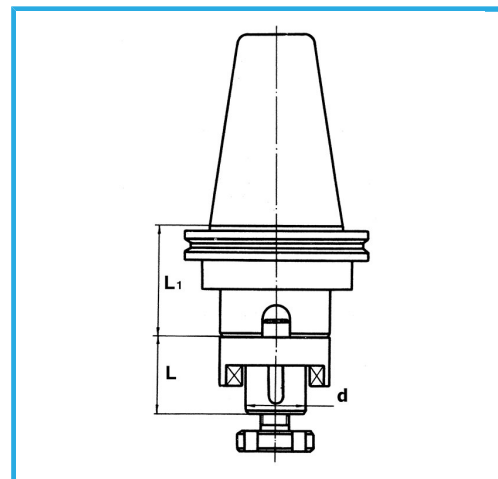

ISO	50
d-h6	32 mm
L	38 mm
L1	40 mm
Balancing rpm	12000
Gross weight	4,94 kg
EAN Code	8012667008154



Box

18Ni  
CrMo5



Grounded