

DIN 69871/A, BALANCED CHUCK BODY, FOR MILLING CUTTERS (WELDON) ACCORDING TO DIN 1835 B AND DIN 6535 HB. SUPPLIED WITH TIGHTENING..

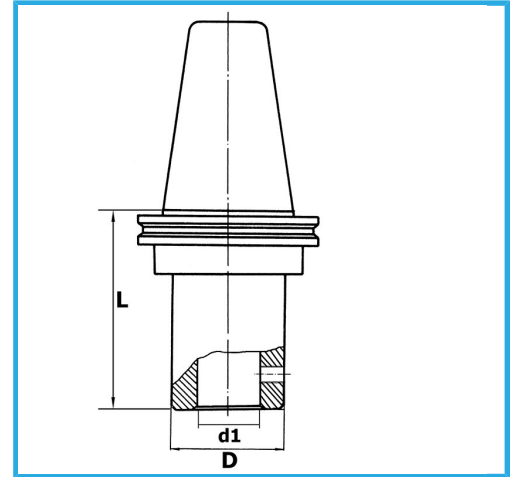

ISO	40
d1 - h6	6 mm
D	25 mm
L	60 mm
Gross weight	0,95 kg
EAN Code	8012667195489



Box



Grounded



18Ni
CrMo5

-