

DIN 69871/A, BALANCED CHUCK BODY, FOR MILLING CUTTERS (WELDON) ACCORDING TO DIN 1835 B AND DIN 6535 HB. SUPPLIED WITH TIGHTENING..

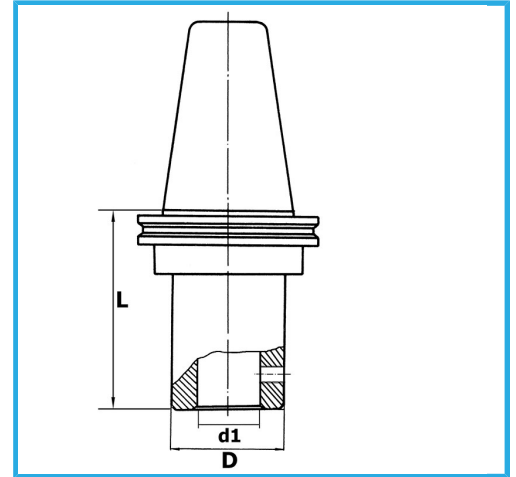

ISO	50
d1 - h6	8 mm
D	28 mm
L	65 mm
Gross weight	3,69 kg
EAN Code	8012667193065



Box



Grounded



18Ni
CrMo5

-