

DIN 69871/A, CON CUERPO EQUILIBRADO, PARA FRESAS (WELDON)  
SEGÚN DIN 1835 B Y DIN 6535 HB. SE SUMINISTRA CON TORNILLO  
DE...

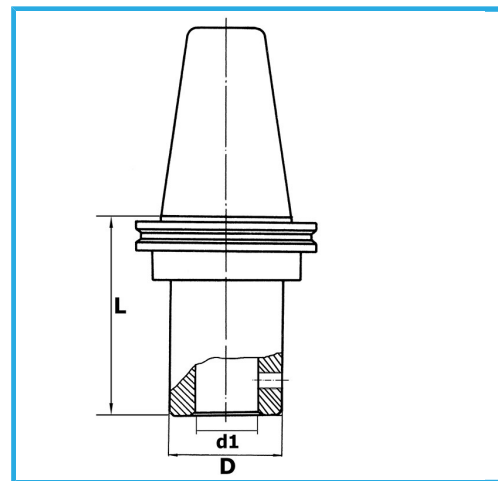

€96,50



ISO	40
d1 - h6	12 mm
D	42 mm
L	60 mm
Peso bruto	1,24 kg
Codigo de barras	8012667195519



Caja



Rectificado

18Ni  
CrMo5

-