

DIN 69871/A, CON CUERPO EQUILIBRADO, PARA FRESAS (WELDON)
SEGÚN DIN 1835 B Y DIN 6535 HB. SE SUMINISTRA CON TORNILLO
DE...

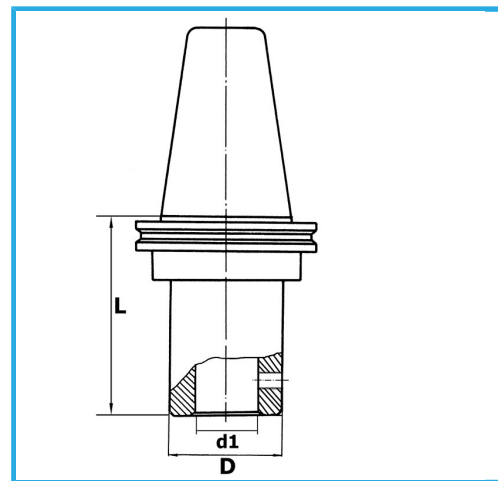

€133,00



ISO	50
d1 - h6	14 mm
D	42 mm
L	75 mm
Peso bruto	3,07 kg
Codigo de barras	8012667193157



Caja



Rectificado

18Ni
CrMo5

-