

DIN 69871/A, BALANCED CHUCK BODY, FOR MILLING CUTTERS (WELDON) ACCORDING TO DIN 1835 B AND DIN 6535 HB. SUPPLIED WITH TIGHTENING..

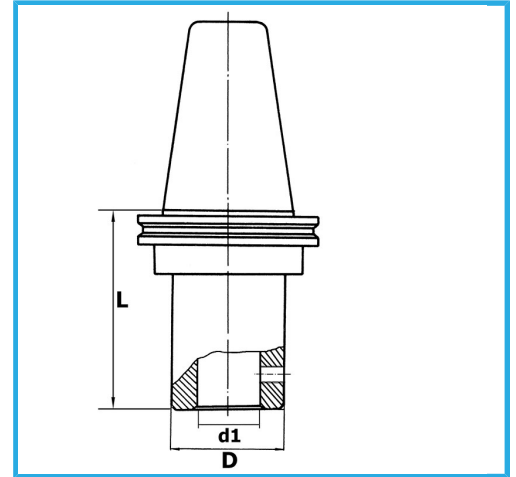

ISO	50
d1 - h6	20 mm
D	52 mm
L	80 mm
Gross weight	3,50 kg
EAN Code	8012667187576



Box



Grounded

18Ni  
CrMo5

-