

DIN 69871/A, CON CUERPO EQUILIBRADO, PARA FRESAS (WELDON)
SEGÚN DIN 1835 B Y DIN 6535 HB. SE SUMINISTRA CON TORNILLO
DE...

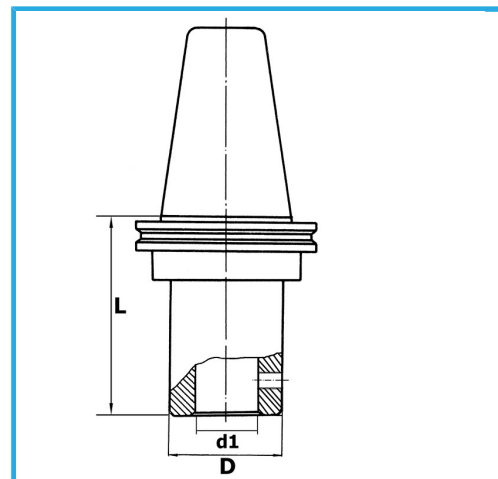

€96,50



ISO	40
d1 - h6	25 mm
D	40 mm
L	100 mm
Peso bruto	2,35 kg
Codigo de barras	8012667195847



Caja



Rectificado

18Ni
CrMo5

-