

DIN 69871/A, BALANCED CHUCK BODY, FOR MILLING CUTTERS (WELDON) ACCORDING TO DIN 1835 B AND DIN 6535 HB. SUPPLIED WITH TIGHTENING..

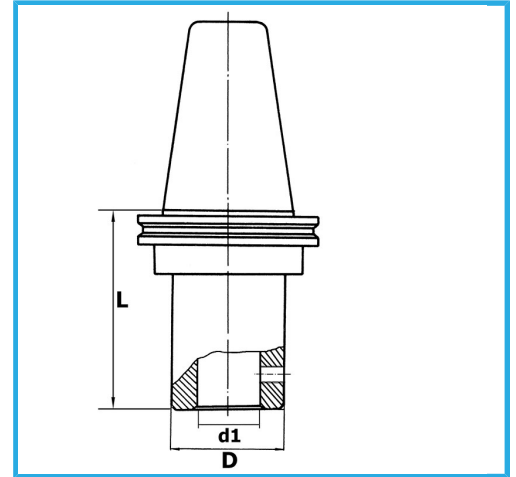

ISO	50
d1 - h6	32 mm
D	72 mm
L	105 mm
Gross weight	4,79 kg
EAN Code	8012667187590



Box



Grounded

18Ni
CrMo5

-