

DIN 69871/A, CON CUERPO EQUILIBRADO, PARA FRESAS (WELDON)
SEGÚN DIN 1835 B Y DIN 6535 HB. SE SUMINISTRA CON TORNILLO
DE...

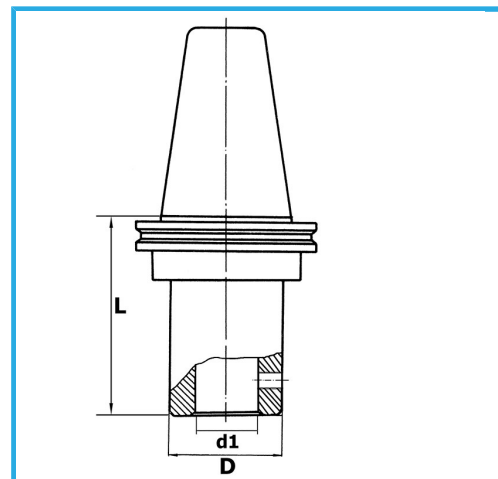

€140,00



ISO	50
d1 - h6	32 mm
D	72 mm
L	105 mm
Peso bruto	4,79 kg
Codigo de barras	8012667187590



Caja



Rectificado

18Ni
CrMo5