

DIN 69871/A, BALANCED CHUCK BODY, FOR MILLING CUTTERS (WELDON) ACCORDING TO DIN 1835 B AND DIN 6535 HB. SUPPLIED WITH TIGHTENING..

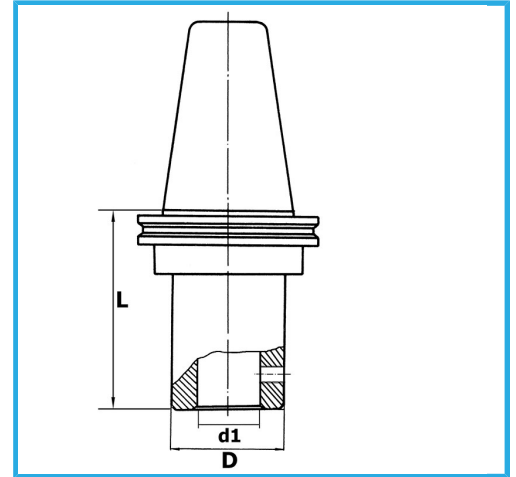

ISO	50
d1 - h6	40 mm
D	80 mm
L	120 mm
Gross weight	5,86 kg
EAN Code	8012667187613



Box



Grounded

18Ni  
CrMo5

-