

DIN 69871/A, CON CUERPO EQUILIBRADO, PARA FRESAS CILÍNDRICAS SEGÚN DIN 481, PARA FRESAS CON RANURA LONGITUDINAL DIN...

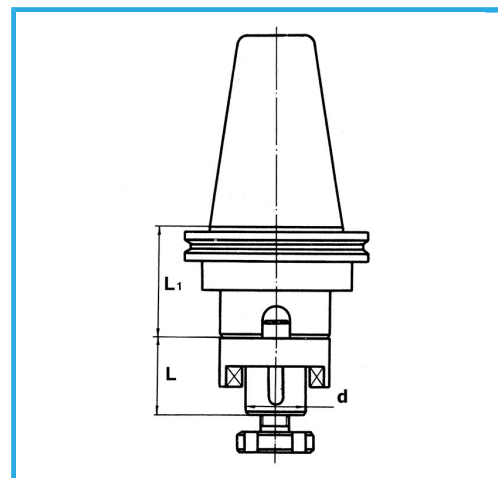

€192,00



ISO	50
Diámetro	40 mm
L	41 mm
L1	40 mm
Equilibrado rpm	12000
Peso bruto	4,12 kg
Codigo de barras	8012667008161



Caja

18Ni  
CrMo5



Rectificado