

DIN 69871/A, BALANCED CHUCK BODY, WITH EXTRACTION SLOT FOR TOOLS. BALANCING 12.000 RPM.

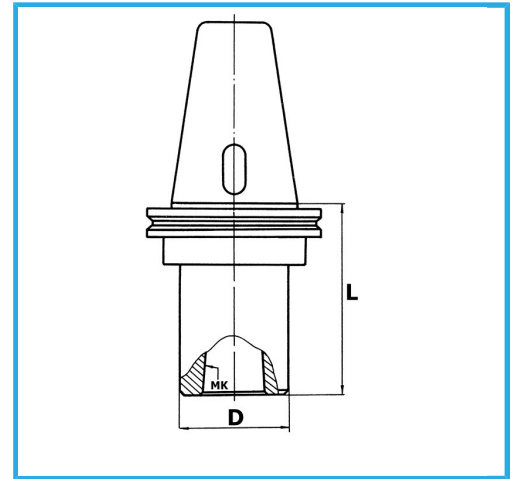

ISO	40
MT	2
D	32 mm
L	60 mm
Gross weight	1,09 kg
EAN Code	8012667007782



Box



Grounded



18Ni
CrMo5

-