

DIN 69871/A, CON CUERPO EQUILIBRADO, CON RANURA DE EXTRACCIÓN PARA HERRAMIENTAS. EQUILIBRADO 12.000 RPM.

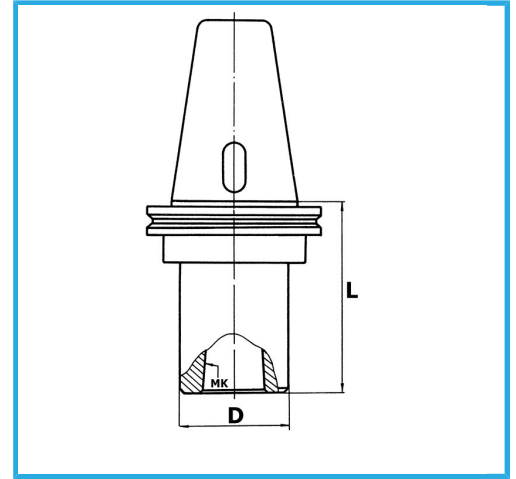

€211,00



ISO	50
CM	2
D	32 mm
L	40 mm
Peso bruto	2,63 kg
Codigo de barras	8012667007867



Caja



Rectificado

18Ni
CrMo5

-