

DIN 69871/A, BALANCED CHUCK BODY, WITH EXTRACTION SLOT FOR TOOLS. BALANCING 12.000 RPM.

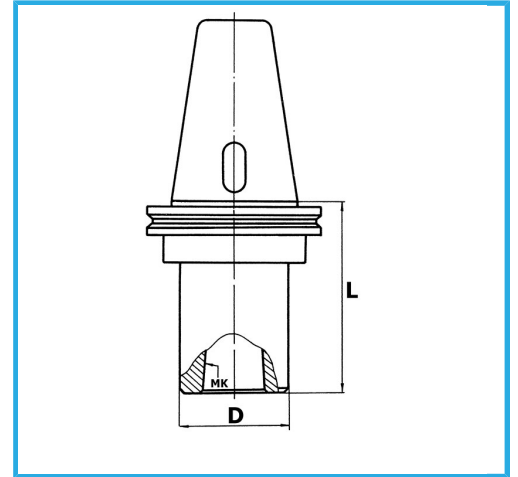

ISO	40
MT	3
D	40 mm
L	75 mm
Gross weight	1,16 kg
EAN Code	8012667007799



Box



Grounded



18Ni
CrMo5

-