

DIN 69871/A, BALANCED CHUCK BODY, WITH EXTRACTION SLOT FOR TOOLS. BALANCING 12.000 RPM.

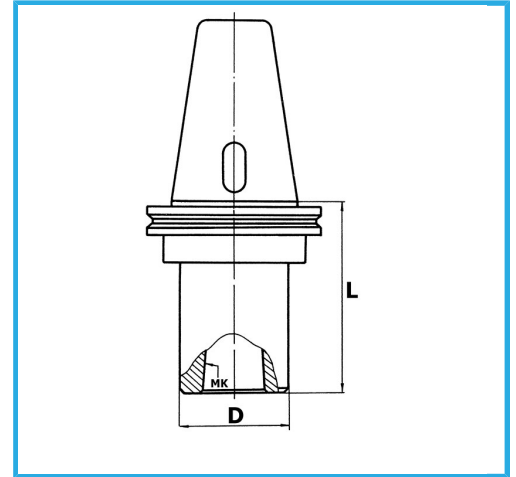

ISO	50
MT	3
D	40 mm
L	50 mm
Gross weight	2,85 kg
EAN Code	8012667007874



Box



Grounded



18Ni
CrMo5

-