

DIN 69871/A, BALANCED CHUCK BODY, WITH EXTRACTION SLOT FOR TOOLS. BALANCING 12.000 RPM.

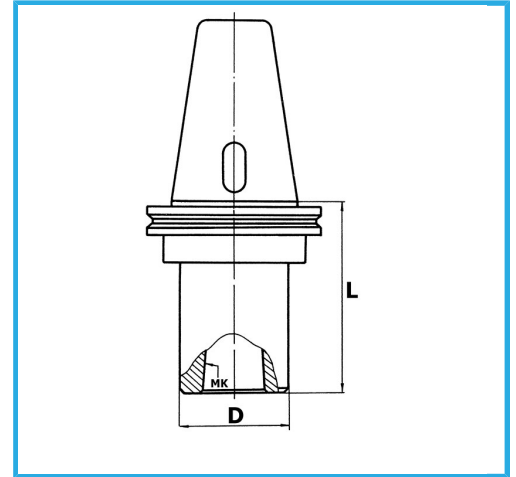

ISO	40
MT	4
D	50 mm
L	98 mm
Gross weight	1,33 kg
EAN Code	8012667007805



Box



Grounded



18Ni
CrMo5

-