

DIN 69871/A, BALANCED CHUCK BODY, WITH EXTRACTION SLOT FOR TOOLS. BALANCING 12.000 RPM.

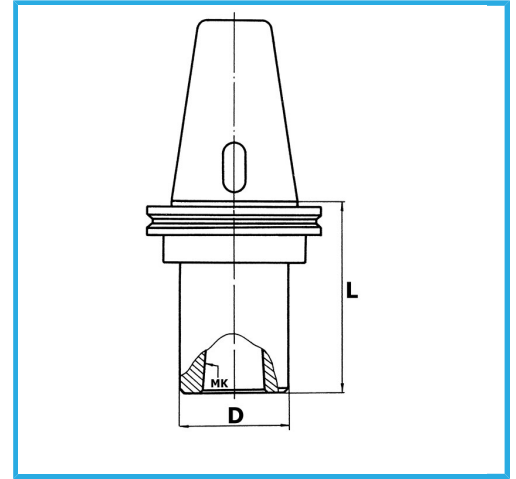

ISO	50
MT	4
D	48 mm
L	95 mm
Gross weight	3,00 kg
EAN Code	8012667007881



Box



Grounded

18Ni
CrMo5

-