

DIN 69871/A, CON CUERPO EQUILIBRADO, CON RANURA DE EXTRACCIÓN PARA HERRAMIENTAS. EQUILIBRADO 12.000 RPM.

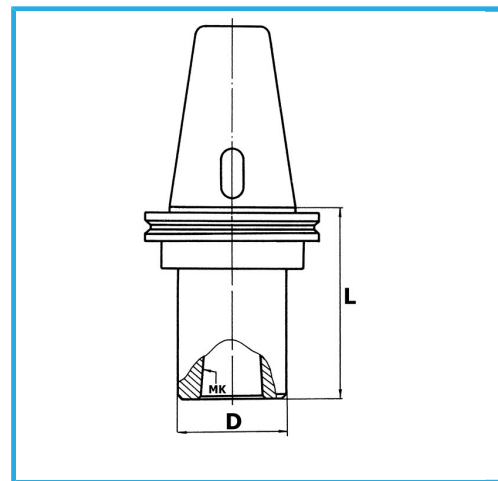

€211,00



ISO	50
CM	4
D	48 mm
L	95 mm
Peso bruto	3,00 kg
Codigo de barras	8012667007881



Caja



Rectificado

18Ni
CrMo5