

DIN 69871/A, BALANCED CHUCK BODY, WITH EXTRACTION SLOT FOR TOOLS. BALANCING 12.000 RPM.

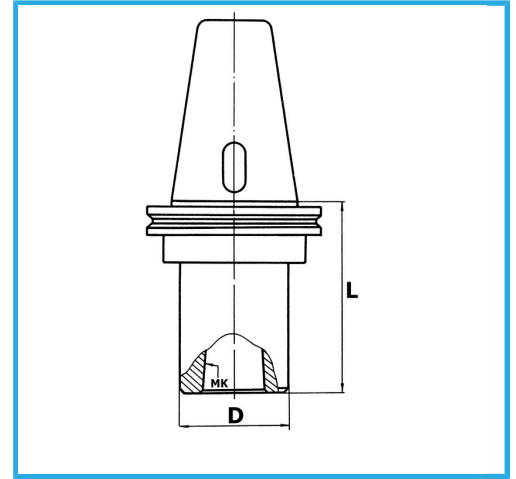

ISO	50
MT	5
D	63 mm
L	110 mm
Gross weight	3,29 kg
EAN Code	8012667007898



Box



Grounded



18Ni
CrMo5

-