

DIN 69871/A, CON CUERPO EQUILIBRADO, CON RANURA DE EXTRACCIÓN PARA HERRAMIENTAS. EQUILIBRADO 12.000 RPM.

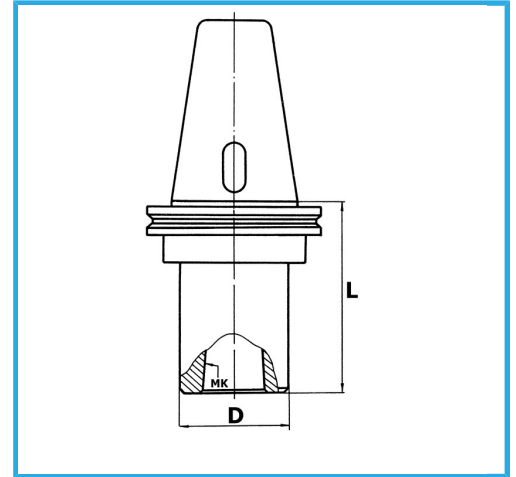

€211,00



ISO	50
CM	5
D	63 mm
L	110 mm
Peso bruto	3,29 kg
Codigo de barras	8012667007898



Caja



Rectificado

18Ni
CrMo5