

DIN 69871/A, BALANCED CHUCK BODY. BALANCING 12.000 RPM.

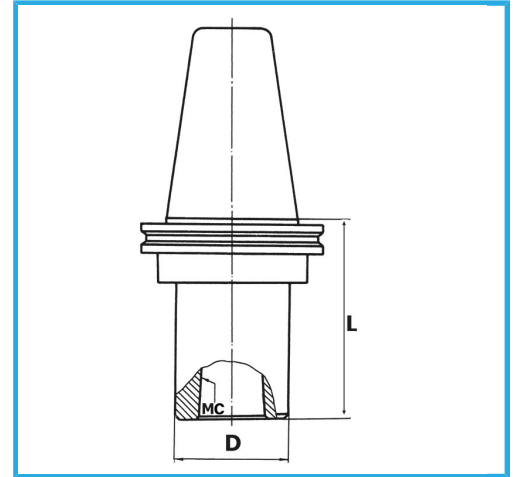

ISO	40
MT	2
D	32 mm
L	60 mm
Gross weight	1,23 kg
EAN Code	8012667007911



Box



Grounded



18Ni
CrMo5

-