

DIN 69871/A, BALANCED CHUCK BODY. BALANCING 12.000 RPM.

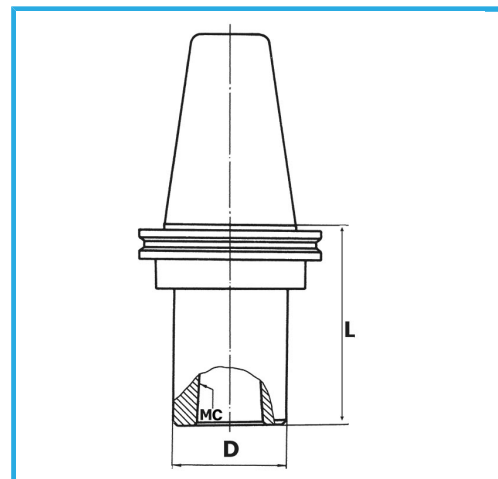

ISO	50
MT	2
D	32 mm
L	40 mm
Gross weight	2,77 kg
EAN Code	8012667007997



Box



Grounded



18Ni
CrMo5

-