

DIN 69871/A, CON CUERPO EQUILIBRADO. EQUILIBRADO 12.000 RPM.

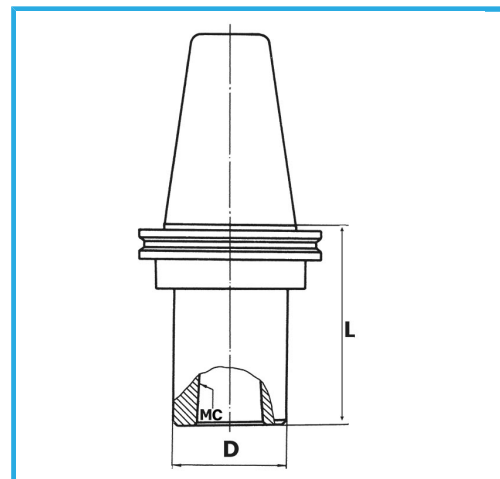

€165,00



ISO	50
CM	2
D	32 mm
L	40 mm
Peso bruto	2,77 kg
Codigo de barras	8012667007997



Caja



Rectificado

18Ni  
CrMo5