

DIN 69871/A, BALANCED CHUCK BODY. BALANCING 12.000 RPM.

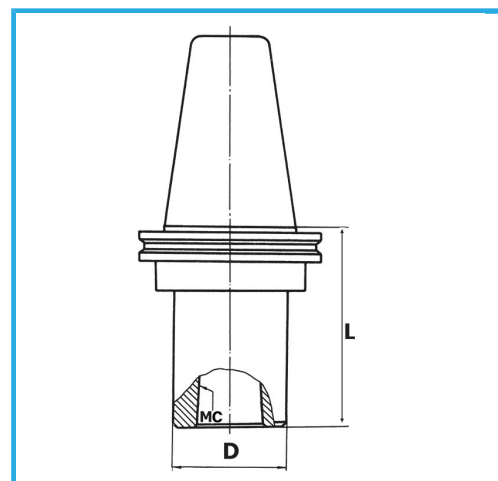

ISO	40
MT	3
D	40 mm
L	75 mm
Gross weight	1,23 kg
EAN Code	8012667007928



Box



Grounded



18Ni
CrMo5

-