

DIN 69871/A, CON CUERPO EQUILIBRADO. EQUILIBRADO 12.000 RPM.

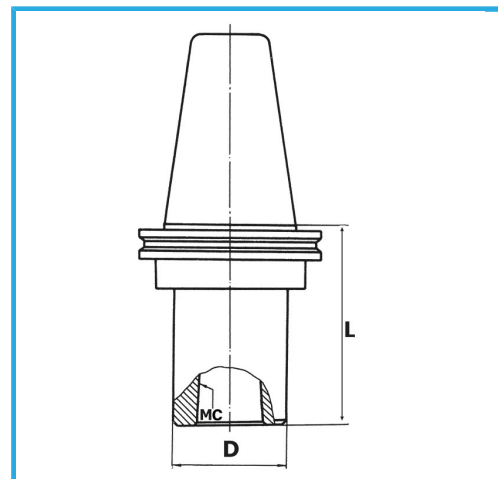

€133,00



ISO	40
CM	3
D	40 mm
L	75 mm
Peso bruto	1,23 kg
Codigo de barras	8012667007928



Caja



Rectificado

18Ni  
CrMo5