

DIN 69871/A, CON CUERPO EQUILIBRADO. EQUILIBRADO 12.000 RPM.

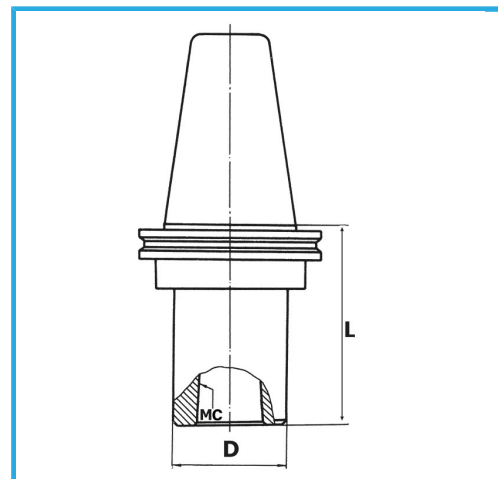

€165,00



ISO	50
CM	3
D	40 mm
L	50 mm
Peso bruto	3,12 kg
Codigo de barras	8012667008000



Caja



Rectificado

18Ni
CrMo5