

DIN 69871/A, CON CUERPO EQUILIBRADO. EQUILIBRADO 12.000 RPM.

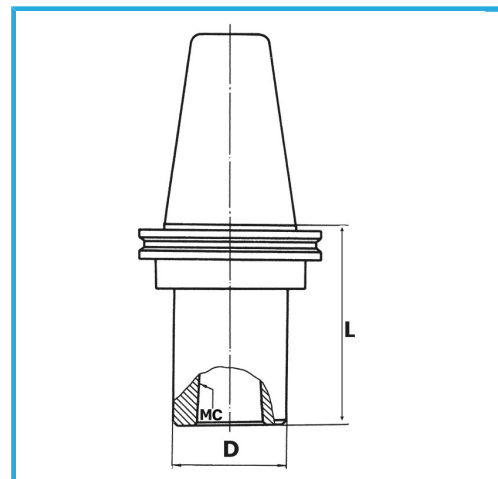

€133,00



ISO	40
CM	4
D	50 mm
L	98 mm
Peso bruto	1,00 kg
Codigo de barras	8012667007935



Caja



Rectificado



18Ni
CrMo5