

DIN 69871/A, CON CUERPO EQUILIBRADO. EQUILIBRADO 12.000 RPM.

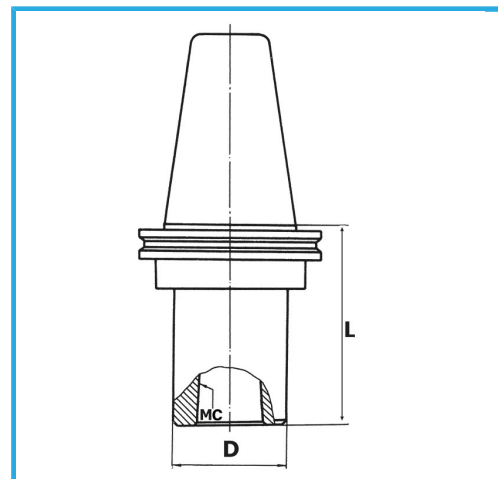

€187,00



ISO	50
CM	4
D	50 mm
L	80 mm
Peso bruto	3,55 kg
Codigo de barras	8012667008017



Caja



Rectificado



18Ni
CrMo5