

DIN 69871/A.

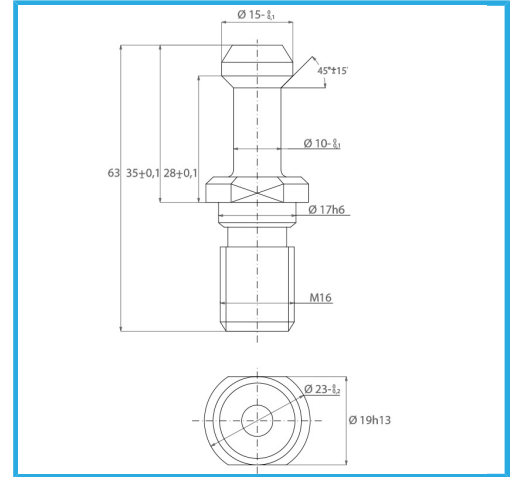

ISO

40

Gross weight

0,08 kg

EAN Code

8012667008178



Box



Tempered



Steel