

MAS-403 BT, CON CUERPO EQUILIBRADO, PARA FRESAS (WELDON)
SEGÚN DIN 1835 B Y DIN 6535 HB. SE SUMINISTRA CON TORNILLO
DE...

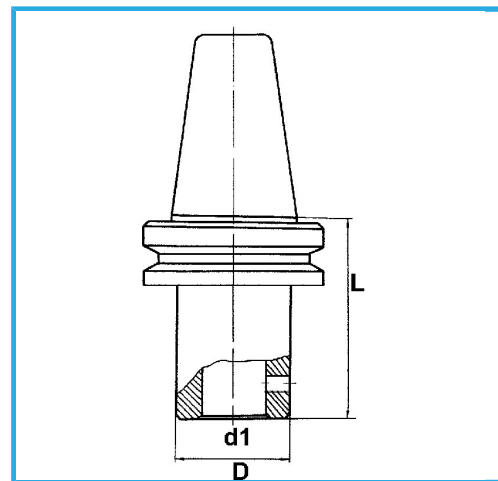

€138,00



Buril	50
d1 - h6	6 mm
D	25 mm
L	65 mm
Peso bruto	3,66 kg
Codigo de barras	8012667193058



Caja



Rectificado

18Ni
CrMo5