

MAS-403 BT, BALANCED CHUCK BODY, FOR MILLING CUTTERS (WELDON) ACCORDING TO DIN 1835 B AND DIN 6535 HB. SUPPLIED WITH TIGHTENING...

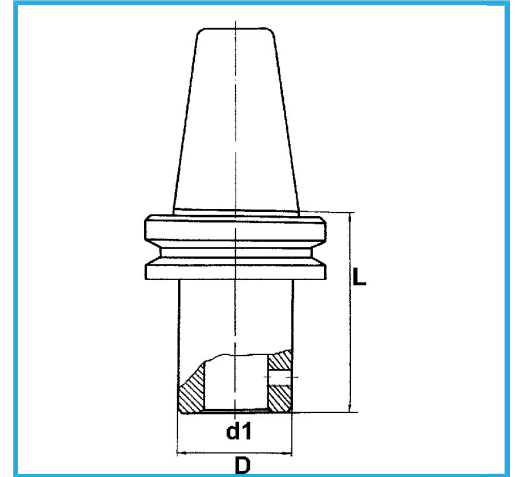

BT	40
d1 - h6	8 mm
D	28 mm
L	60 mm
Gross weight	1,12 kg
EAN Code	8012667195885



Box



Grounded



18Ni  
CrMo5

-