

MAS-403 BT, BALANCED CHUCK BODY, FOR MILLING CUTTERS
(WELDON) ACCORDING TO DIN 1835 B AND DIN 6535 HB. SUPPLIED
WITH TIGHTENING...

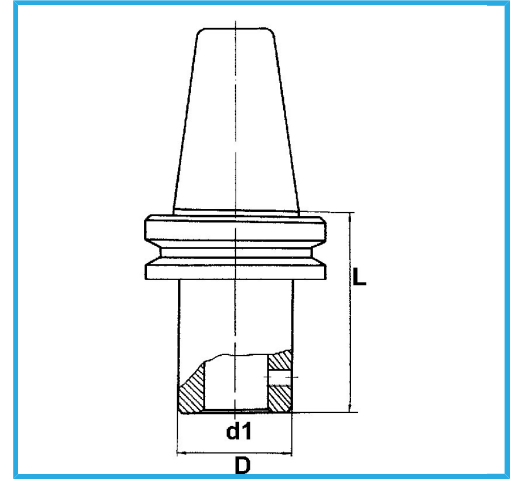

BT	50
d1 - h6	10 mm
D	35 mm
L	70 mm
Gross weight	3,75 kg
EAN Code	8012667193119



Box



Grounded



18Ni
CrMo5

-