

MAS-403 BT, CON CUERPO EQUILIBRADO, PARA FRESAS (WELDON)  
SEGÚN DIN 1835 B Y DIN 6535 HB. SE SUMINISTRA CON TORNILLO  
DE...

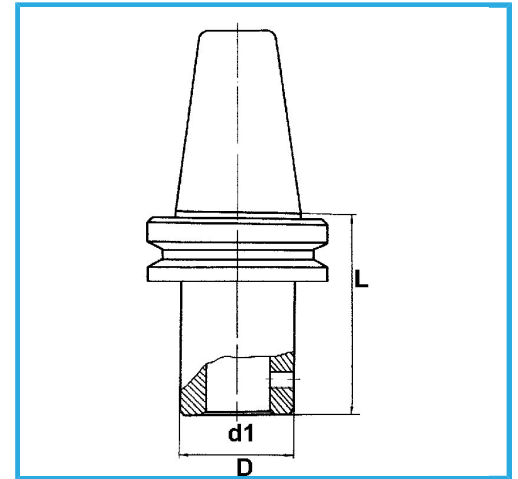

€138,00



Buril	50
d1 - h6	10 mm
D	35 mm
L	70 mm
Peso bruto	3,75 kg
Codigo de barras	8012667193119



Caja



Rectificado



18Ni  
CrMo5