

MAS-403 BT, BALANCED CHUCK BODY, FOR MILLING CUTTERS  
(WELDON) ACCORDING TO DIN 1835 B AND DIN 6535 HB. SUPPLIED  
WITH TIGHTENING...

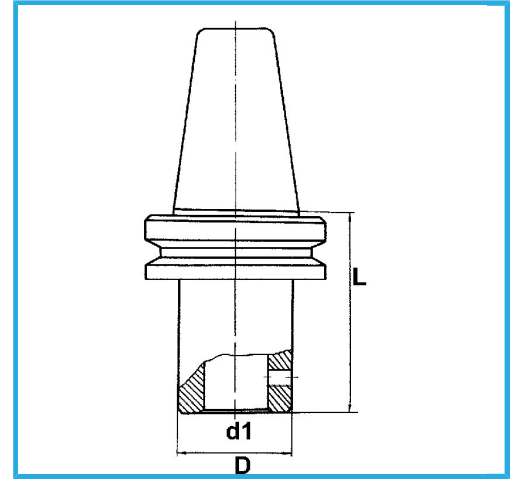

BT	50
d1 - h6	12 mm
D	42 mm
L	75 mm
Gross weight	3,96 kg
EAN Code	8012667193140



Box



Grounded



18Ni  
CrMo5

-