

MAS-403 BT, CON CUERPO EQUILIBRADO, PARA FRESAS (WELDON)  
SEGÚN DIN 1835 B Y DIN 6535 HB. SE SUMINISTRA CON TORNILLO  
DE...

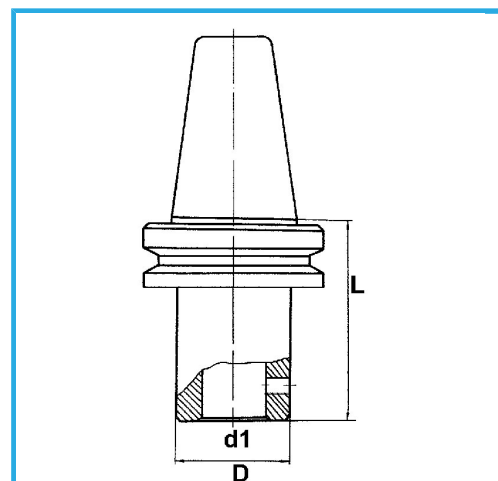

€138,00



Buril	50
d1 - h6	12 mm
D	42 mm
L	75 mm
Peso bruto	3,96 kg
Codigo de barras	8012667193140



Caja



Rectificado

18Ni  
CrMo5