

MAS-403 BT, CON CUERPO EQUILIBRADO, PARA FRESAS (WELDON)
SEGÚN DIN 1835 B Y DIN 6535 HB. SE SUMINISTRA CON TORNILLO
DE...

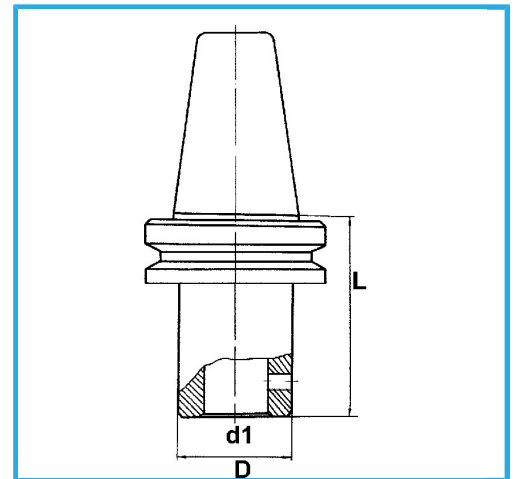

€105,00



Buril	40
d1 - h6	18 mm
D	48 mm
L	70 mm
Peso bruto	1,49 kg
Codigo de barras	8012667195984



Caja



Rectificado



18Ni
CrMo5