

MAS-403 BT, CON CUERPO EQUILIBRADO, PARA FRESAS (WELDON)
SEGÚN DIN 1835 B Y DIN 6535 HB. SE SUMINISTRA CON TORNILLO
DE...

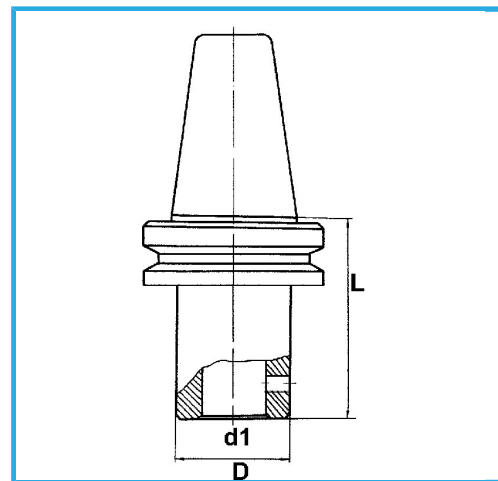

€138,00



Buril	50
d1 - h6	20 mm
D	52 mm
L	80 mm
Peso bruto	4,13 kg
Codigo de barras	8012667195427



Caja



Rectificado



18Ni
CrMo5