

MAS-403 BT, BALANCED CHUCK BODY, FOR MILLING CUTTERS  
(WELDON) ACCORDING TO DIN 1835 B AND DIN 6535 HB. SUPPLIED  
WITH TIGHTENING...

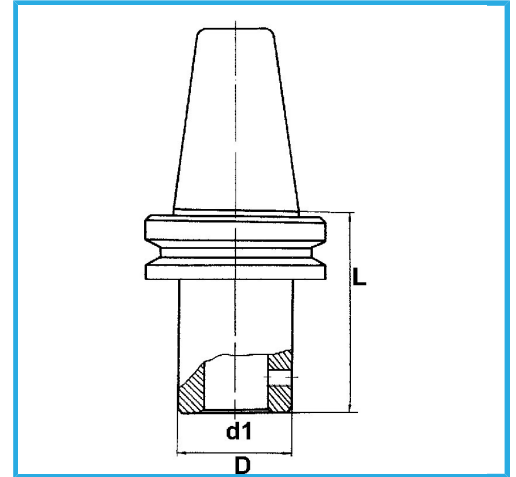

BT	40
d1 - h6	25 mm
D	63 mm
L	100 mm
Gross weight	2,50 kg
EAN Code	8012667196035



Box



Grounded



18Ni  
CrMo5

-