

MAS-403 BT, BALANCED CHUCK BODY, FOR MILLING CUTTERS
(WELDON) ACCORDING TO DIN 1835 B AND DIN 6535 HB. SUPPLIED
WITH TIGHTENING...

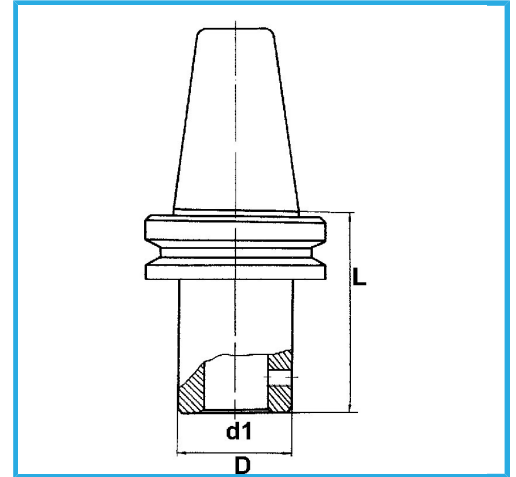

BT	40
d1 - h6	32 mm
D	72 mm
L	100 mm
Gross weight	2,00 kg
EAN Code	8012667196059



Box



Grounded



18Ni
CrMo5

-