

MAS-403 BT, CON CUERPO EQUILIBRADO, PARA FRESAS (WELDON)  
SEGÚN DIN 1835 B Y DIN 6535 HB. SE SUMINISTRA CON TORNILLO  
DE...

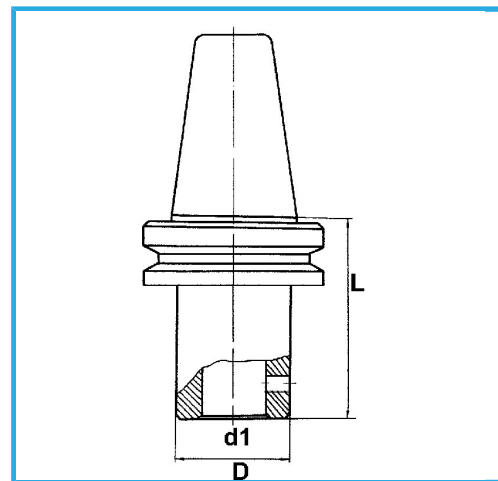

€154,00



Buril	50
d1 - h6	40 mm
D	80 mm
L	120 mm
Peso bruto	6,66 kg
Codigo de barras	8012667195458



Caja



Rectificado



18Ni  
CrMo5