

MAS-403 BT, CON CUERPO EQUILIBRADO, PARA FRESAS CILÍNDRICAS SEGÚN DIN 481, PARA FRESAS CON RANURA LONGITUDINAL DIN...

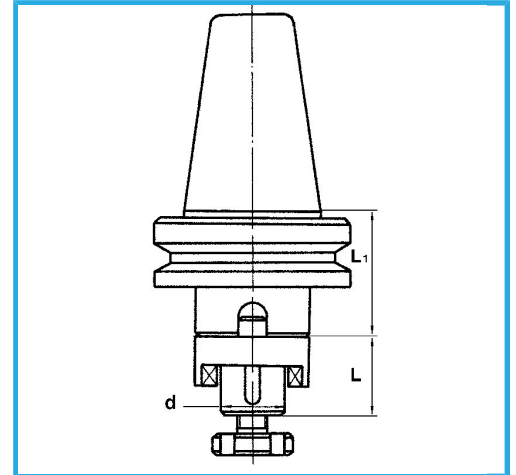

€119,00



Buril	40
d - h6	16 mm
L	27 mm
L1	35 mm
Peso bruto	1,31 kg
Codigo de barras	8012667008536



Caja



Templado



Rectificado



18Ni
CrMo5