

MAS-403 BT, BALANCED CHUCK BODY, FOR CYLINDRICAL END MILLS ACCORDING TO DIN 481, FOR MILLING CUTTERS WITH LONGITUDINAL GROOVE...

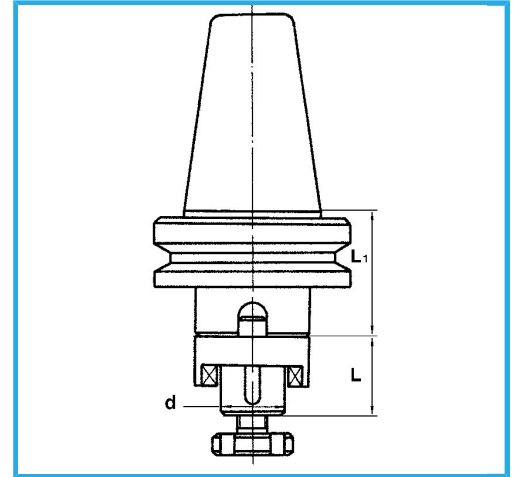

BT	50
d - h6	16 mm
L	27 mm
L1	35 mm
Gross weight	4,16 kg
EAN Code	8012667008574



Box



Tempered



Grounded



18Ni
CrMo5