

MAS-403 BT, CON CUERPO EQUILIBRADO, PARA FRESAS CILÍNDRICAS SEGÚN DIN 481, PARA FRESAS CON RANURA LONGITUDINAL DIN...

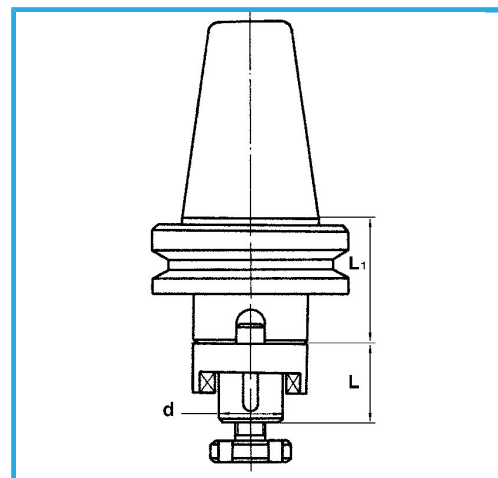

€119,00



Buril	40
d - h6	22 mm
L	31 mm
L1	35 mm
Peso bruto	2,00 kg
Codigo de barras	8012667008543



Caja



Templado



Rectificado



18Ni
CrMo5