

MAS-403 BT, BALANCED CHUCK BODY, FOR CYLINDRICAL END MILLS  
ACCORDING TO DIN 481, FOR MILLING CUTTERS WITH LONGITUDINAL  
GROOVE...

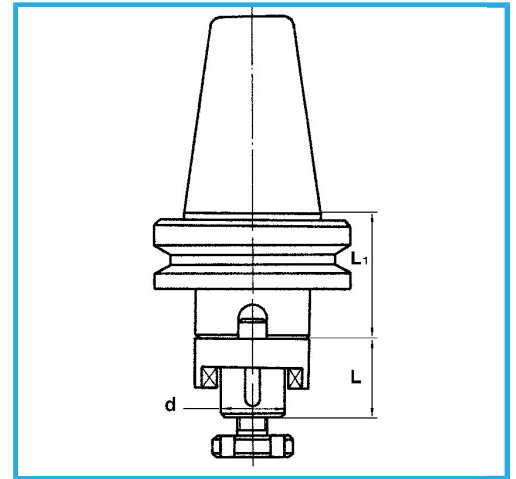

BT	50
d - h6	32 mm
L	38 mm
L1	40 mm
Gross weight	4,76 kg
EAN Code	8012667008604



Box



Tempered



Grounded



18Ni  
CrMo5